

CATALOGO 2026

INDICE CATALOGO BAULED 2026

LAMPADINE LED	3
LAMPADINE SMART	4
LAMPADINA GU10	5
TUBO LED	7
FARETTI DA INCASSO	9
SERIE MODULARE	11
SERIE TRACKLIGHT E SPOTLIGHT	13
RIFLETTORI	16
FARI LED	19
PANNELLI AD INCASTRO	20
STRISCE LED	22
PROFILI LED	25
SENSORI	27
PLAFONIERE STAGNA LED	28
TRACK RAIL	29
LED LINEARI	31

LAMPADINE LED



MODEL : **KL LA02-0520-CLF**
 MODEL : **KL LA02-0521-CLF**
 MODEL : **KL LA02-0720-CLE**
 MODEL : **KL LA02-0721-CLE**
 MODEL : **KL LA02-0722-CLE**

MODEL : KL LA02-0520-CLF	4,9	40	470	3000	200	E14	15000	≥25000	F
MODEL : KL LA02-0521-CLF	4,9	40	470	4000	200	E14	15000	≥25000	F
MODEL : KL LA02-0720-CLE	6,5	60	806	3000	200	E14	20000	≥25000	E
MODEL : KL LA02-0721-CLE	6,5	60	806	4000	200	E14	20000	≥25000	E
MODEL : KL LA02-0722-CLE	6,5	60	806	6500	200	E14	20000	≥25000	E

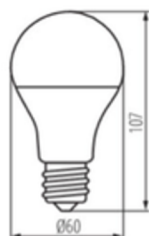

MODEL : **KL LA04-0820-CLF**
 MODEL : **KL LA04-0821-CLF**
 MODEL : **KL LA04-1020-CLE**
 MODEL : **KL LA04-1021-CLE**
 MODEL : **KL LA04-1320-CLE**
 MODEL : **KL LA04-1321-CLE**
 MODEL : **KL LA04-1322-CLE**

MODEL : KL LA04-0820-CLF	8	60	810	4000	180	E27	F
MODEL : KL LA04-0821-CLF	8	60	810	3000	180	E27	F
MODEL : KL LA04-1020-CLE	9,5	74	1050	4000	180	E27	E
MODEL : KL LA04-1021-CLE	9,5	74	1050	3000	180	E27	E
MODEL : KL LA04-1320-CLE	13	99	1520	4000	180	E27	E
MODEL : KL LA04-1321-CLE	13	99	1520	3000	180	E27	E
MODEL : KL LA04-1322-CLE	13	99	1520	6500	180	E27	E



MODEL : **KL LA04-0320-IQ-LED-CLD**
 MODEL : **KL LA04-0321-IQ-LED-CLD**
 MODEL : **KL LA04-0322-IQ-LED-CLD**
 MODEL : **KL LA04-0620-IQ-LED-CLD**
 MODEL : **KL LA04-0621-IQ-LED-CLD**
 MODEL : **KL LA04-0622-IQ-LED-CLD**
 MODEL : **KL LA04-0820-IQ-LED-CLD**
 MODEL : **KL LA04-0821-IQ-LED-CLD**
 MODEL : **KL LA04-0822-IQ-LED-CLD**
 MODEL : **KL LA04-1120-IQ-LED-CLD**
 MODEL : **KL LA04-1121-IQ-LED-CLD**
 MODEL : **KL LA04-1122-IQ-LED-CLD**

MODEL : KL LA04-0320-IQ-LED-CLD	3,4	40	470	2700	180	E27	D
MODEL : KL LA04-0321-IQ-LED-CLD	3,4	40	470	4000	180	E27	D
MODEL : KL LA04-0322-IQ-LED-CLD	3,4	40	470	6500	180	E27	D
MODEL : KL LA04-0620-IQ-LED-CLD	5,9	60	806	2700	180	E27	D
MODEL : KL LA04-0621-IQ-LED-CLD	5,9	60	806	4000	180	E27	D
MODEL : KL LA04-0622-IQ-LED-CLD	5,9	60	806	6500	180	E27	D
MODEL : KL LA04-0820-IQ-LED-CLD	7,8	75	1055	2700	180	E27	D
MODEL : KL LA04-0821-IQ-LED-CLD	7,8	75	1055	4000	180	E27	D
MODEL : KL LA04-0822-IQ-LED-CLD	7,8	75	1055	6500	180	E27	D
MODEL : KL LA04-1120-IQ-LED-CLD	11	100	1521	2700	180	E27	D
MODEL : KL LA04-1121-IQ-LED-CLD	11	100	1521	4000	180	E27	D
MODEL : KL LA04-1122-IQ-LED-CLD	11	100	1521	6500	180	E27	D

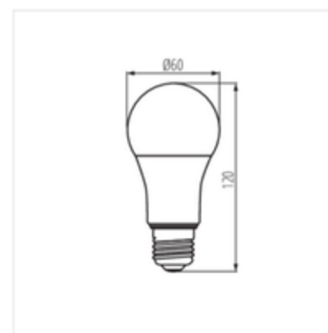

LAMPADINE SMART



MODEL : KL LA14-0724 SMART	7	60	806	2700-6500	320	E27	E
MODEL : KL LA04-0928 SMART	9	60	806	2700-6500	180	E27	F
MODEL : KL LA04-1228 SMART	11,5	75	1055	2700-6500	180	E27	F
MODEL : KL LA06-0528 SMART	4,7	39	325	2700-6500	110	GU10	G

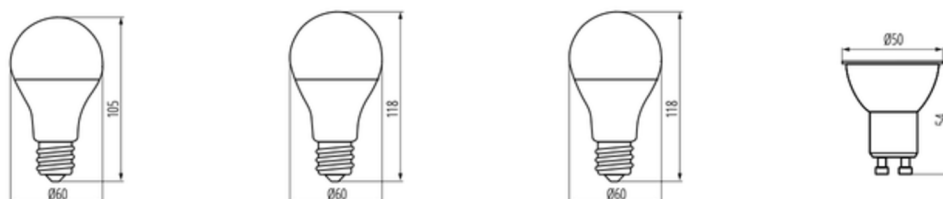

LAMPADINE LED 2



MODEL : KL LA11-0520 CLF	4,5	40	470	2700	320	E27	≥15000	F
MODEL : KL LA11-0521 CLF	4,5	40	470	4000	320	E27	≥15000	F

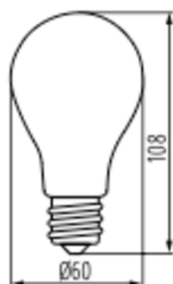

MODEL : KL LA14-0420-CLA	4	62	840	2700	320	E27	A
MODEL : KL LA14-0421-CLA	4	62	840	4000	320	E27	A
MODEL : KL LA14-0520-CLA	5	75	1055	2700	320	E27	A
MODEL : KL LA14-0521-CLA	5	75	1055	4000	320	E27	A
MODEL : KL LA14-0720-CLA	7,2	100	1521	2700	320	E27	A
MODEL : KL LA14-0721-CLA	7,2	100	1521	4000	320	E27	A



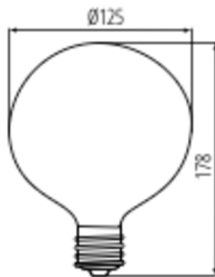

MODEL : **KL LA05-1120-CLD**

MODEL : **KL LA05-1121-CLD**



11	99	1520	2700	320	E27	D
11	99	1520	4000	320	E27	D

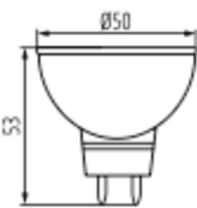

MODEL : **KL LA60-0520-TOMI-CLG**

MODEL : **KL LA60-0522-TOMI-CLG**

MODEL : **KL LA60-0720-TOMI-CLG**

MODEL : **KL LA60-0722-TOMI-CLG**



5	26	370	300	3000	120	Gx5,3	G
5	27	390	310	5300	120	Gx5,3	G
7	35	570	470	3000	120	Gx5,3	G
7	35	580	480	5300	120	Gx5,3	G



LAMPADINA GU10



MODEL : **KL LA06-0420 - CLF**

MODEL : **KL LA06-0421 - CLF**

MODEL : **KL LA06-0422 - CLF**

MODEL : **KL LA06-0620 - CLG**

MODEL : **KL LA06-0621 - CLG**

MODEL : **KL LA06-0622 - CLG**

MODEL : **KL LA06-0820 - CLG**

MODEL : **KL LA06-0821 - CLG**

MODEL : **KL LA06-0822 - CLG**



4	35	380	320	3000	100	GU10	F
4	35	380	320	4000	100	GU10	F
4	35	380	320	5000	100	GU10	F
6	45	520	430	3000	100	GU10	G
6	45	520	430	4000	100	GU10	G
6	45	520	430	5000	100	GU10	G
8	57	690	560	3000	100	GU10	G
8	57	690	560	4000	100	GU10	G
8	57	690	560	5000	100	GU10	G



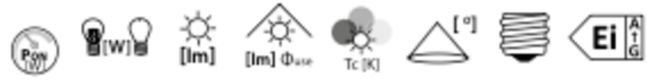

MODEL : KL LA06-0120 -TOMiv2 - CLF	1,2	15	120	105	<u>3000</u>	100	GU10	F
MODEL : KL LA06-0121 -TOMiv2 - CLF	1,2	15	120	105	<u>4000</u>	100	GU10	F
MODEL : KL LA06-0122 -TOMiv2 - CLF	1,2	15	120	105	<u>6500</u>	100	GU10	F
MODEL : KL LA06-0320 -TOMiv2 - CLF	2,9	28	295	240	<u>3000</u>	100	GU10	F
MODEL : KL LA06-0321 -TOMiv2 - CLF	2,9	28	295	240	<u>4000</u>	100	GU10	F
MODEL : KL LA06-0322 -TOMiv2 - CLF	2,9	28	295	240	<u>6500</u>	100	GU10	F
MODEL : KL LA06-0520 -TOMiv2 - CLF	4,9	42	490	400	<u>3000</u>	100	GU10	F
MODEL : KL LA06-0521 -TOMiv2 - CLF	4,9	42	490	400	<u>4000</u>	100	GU10	F
MODEL : KL LA06-0522 -TOMiv2 - CLF	4,9	42	490	400	<u>6500</u>	100	GU10	F
MODEL : KL LA06-0720 -TOMiv2 - CLF	6,5	61	650	530	<u>3000</u>	100	GU10	F
MODEL : KL LA06-0721 -TOMiv2 - CLF	6,5	61	650	530	<u>4000</u>	100	GU10	F
MODEL : KL LA06-0722 -TOMiv2 - CLF	6,5	61	650	530	<u>6500</u>	100	GU10	F



MODEL : KL LA06-0520-IQ-LED- CLE	4,9	44	550	2700	120	GU10	E
MODEL : KL LA06-0521-IQ-LED- CLE	4,9	44	550	4000	120	GU10	E
MODEL : KL LA06-0522-IQ-LED- CLE	4,9	44	550	6500	120	GU10	E

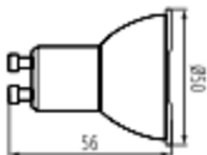

MODEL : KL LA06-0321-IQ-LED-CLA	2,5	54	460	450	4000	100	GU10	A
MODEL : KL LA06-0520-IQ-LED-CLA	4,7	89	850	850	3000	100	GU10	A
MODEL : KL LA06-0521-IQ-LED-CLA	4,7	89	850	850	4000	100	GU10	A





MODEL : KL LA06-0720-XLED- CLD	6,5	88	880	850	3000	100	GU10	D
MODEL : KL LA06-0721-XLED- CLD	6,5	88	880	850	4000	100	GU10	D
MODEL : KL LA06-0722-XLED- CLD	6,5	88	880	850	6500	100	GU10	D



TUBO LED

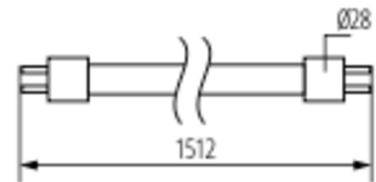
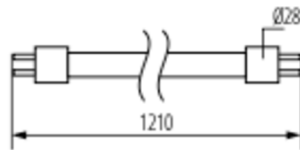
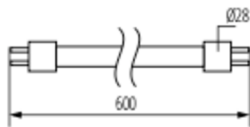

MODEL : KL LA2160-0921-CLF	9	900	4000	200	G13	F
MODEL : KL LA2160-0922-CLF	9	900	6500	200	G13	F
MODEL : KL LA2112-1821-CLF	18	1820	4000	200	G13	F
MODEL : KL LA2112-1822-CLF	18	1820	6500	200	G13	F
MODEL : KL LA2115-2221-CLF	22	2270	4000	200	G13	F
MODEL : KL LA2115-2222-CLF	22	2270	6500	200	G13	F

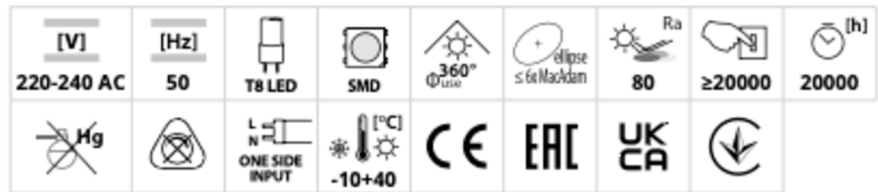



MODEL : KL LA2160-0921-CLD	9	1350	4000	220	G13	D
MODEL : KL LA2160-0922-CLD	9	1350	6500	220	G13	D
MODEL : KL LA2112-1821-CLD	18	2700	4000	220	G13	D
MODEL : KL LA2112-1822-CLD	18	2700	6500	220	G13	D
MODEL : KL LA2115-2221-CLD	22	3300	4000	220	G13	D
MODEL : KL LA2115-2222-CLD	22	3300	6500	220	G13	D

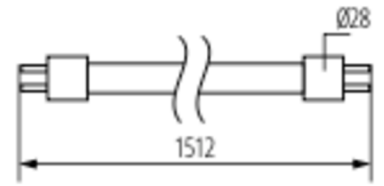
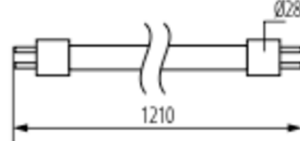
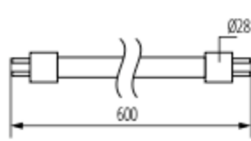

[V] 220-240 AC	[Hz] 50	T8 LED	SMD	360° Φ _{use}	ellipse ≤ 6x MacAdam	Ra 80	≥25000	30000 [h]
			L N ONE SIDE INPUT	-10+40 [°C]	CE	EAC	UK CA	



MODEL : KL LA2160-0921-CLC	9	1440	4000	220	G13	C
MODEL : KL LA2160-0922-CLC	9	1440	6500	220	G13	C
MODEL : KL LA2112-1821-CLC	18	2880	4000	220	G13	C
MODEL : KL LA2112-1822-CLC	18	2880	6500	220	G13	C
MODEL : KL LA2115-2221-CLC	22	3520	4000	220	G13	C
MODEL : KL LA2115-2222-CLC	22	3520	6500	220	G13	C

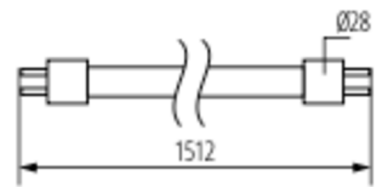
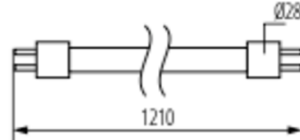
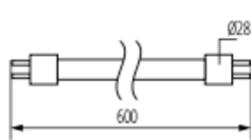

[V] 220-240 AC	[Hz] 50	T8 LED	SMD	360° Φ _{use}	ellipse ≤ 6x MacAdam	Ra 80	≥30000	30000 [h]
			L N ONE SIDE INPUT	-10+40 [°C]	CE	EAC	UK CA	



MODEL : **KL LA2112-1221-CLA**

12 2520 4000 200 G13 A

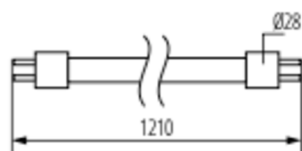

[V] 220-240 AC	[Hz] 50	T8 LED	SMD	360° Φuse	ellipse ≤ 6x MacAdam	Ra 80	≥50000	[h] 50000
		L N ONE SIDE INPUT	-10+40	CE	EAC	UK CA		

FARETTI DA INCASSO

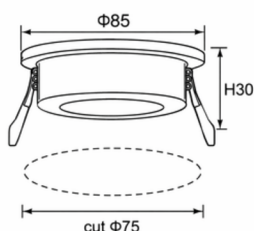

MODEL : **LD30-8510** WHITE-ALUMINIUM

MODEL : **LD30-8515** WHITE+CHROME BLACK-ALUMINIUM

MODEL : **LD30-8520** WHITE+MATT BLACK-ALUMINIUM

MODEL : **LD30-8530** WHITE+SATIN SILVER-ALUMINIUM

MODEL : **LD30-8540** BLACK+WHITE- ALUMINIUM

MODEL : **LD30-8550** MATT BLACK-ALUMINIUM

MODEL : **LD30-8560** BLACK+SATIN SILVER-ALUMINIUM

MODEL : **LD30-8570** BLACK+GREY-ALUMINIUM

MODEL :
LD30-8510



MODEL :
LD30-8515



MODEL :
LD30-8520



MODEL :
LD30-8530



MODEL :
LD30-8540



MODEL :
LD30-8550



MODEL :
LD30-8560



MODEL :
LD30-8570



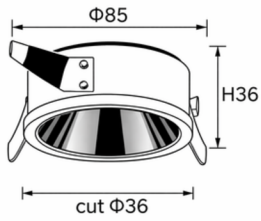

- MODEL : **LD36-8510** WHITE-ALUMINIUM
- MODEL : **LD36-8515** WHITE+MATT BLACK-ALUMINIUM
- MODEL : **LD36-8520** BLACK+CHROME BLACK-ALUMINIUM
- MODEL : **LD36-8530** MATT BLACK-ALUMINIUM
- MODEL : **LD36-8540** WHITE+GREY-ALUMINIUM
- MODEL : **LD36-8550** BLACK+PAINTING GOLD-ALUMINIUM
- MODEL : **LD36-8560** SATIN GUN-ALUMINIUM
- MODEL : **LD36-8570** MAT TEE-ALUMINIUM
- MODEL : **LD36-8580** MAT RED WINE-ALUMINIUM

MODEL :
LD36-8510



MODEL :
LD36-8515



MODEL :
LD36-8520



MODEL :
LD36-8530



MODEL :
LD36-8540



MODEL :
LD36-8550



MODEL :
LD36-8560



MODEL :
LD36-8570



MODEL :
LD36-8580

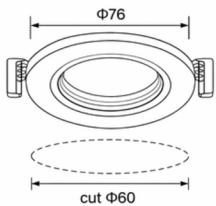

- MODEL : **LD45-0100** WHITE
- MODEL : **LD45-0110** GREY
- MODEL : **LD45-0120** BLACK
- MODEL : **LD45-0130** DARK GREY

MODEL :
LD45-0100



MODEL :
LD45-0110

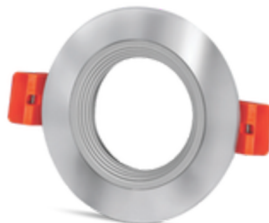

MODEL :
LD45-0120



MODEL :
LD45-0130



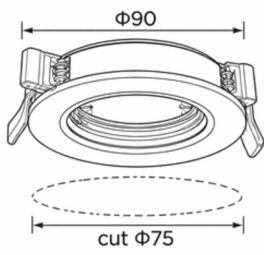

MODEL : **LD42-0215** BLACK
 MODEL : **LD45-0200** WHITE
 MODEL : **LD45-0205** WHITE-GREY
 MODEL : **LD45-0210** SILVER
 MODEL : **LD45-0215** SILVER-BLACK
 MODEL : **LD45-0220** BLACK

MODEL :
LD42-0215

MODEL :
LD45-0200

MODEL :
LD45-0205

MODEL :
LD45-0210

MODEL :
LD45-0215

MODEL :
LD45-0220



SERIE MODULARE

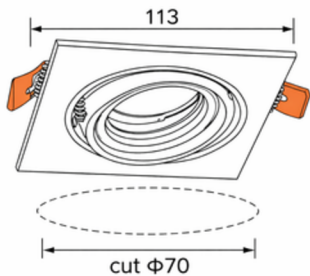

MODEL :
LD46-0110 WHITE
 MODEL :
LD46-0120 BLACK

MODEL :
LD46-0110

MODEL :
LD46-0120

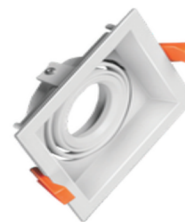

LUXMAINER-MODULE FRAMES

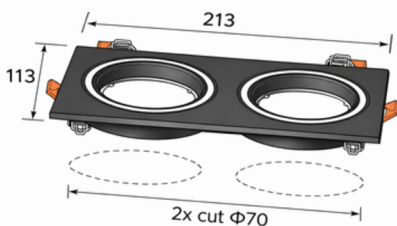

MODEL :
LD47-0210 WHITE
 MODEL :
LD47-0220 BLACK

MODEL :
LD47-0210

MODEL :
LD47-0220



LUXMAINER-MODULE FRAMES

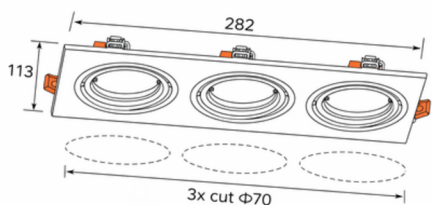

MODEL :
LD48-0310 WHITE
 MODEL :
LD48-0320 BLACK

MODEL :
LD48-0310

MODEL :
LD48-0320



LUXMAINER-MODULE FRAMES

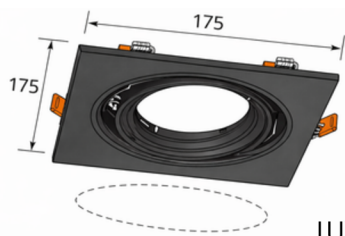

MODEL :
LD46-2120



LUXMAINER-MODULE FRAMES

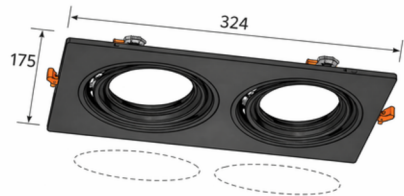

MODEL :
LD47-2220



LUXMAINER-MODULE FRAMES

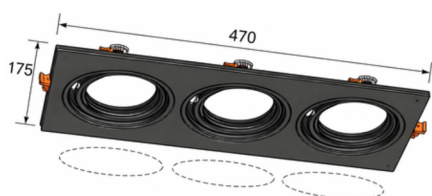

MODEL :
LD48-2320



LUXMAINER-MODULE FRAMES

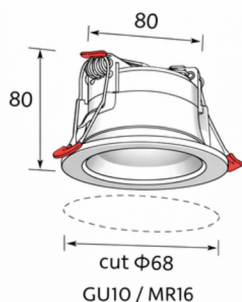

MODEL :
LD51-0100



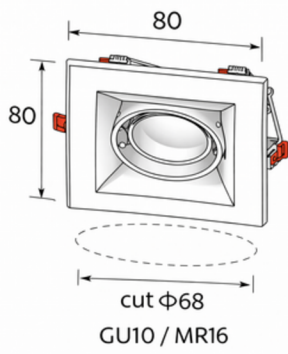

MODEL :
LD52-0100



MODEL :
LD54-0100



MODEL :
LD54-0200



MODEL :
LD54-0300



SERIE TRACKLIGHT E SPOTLIGHT

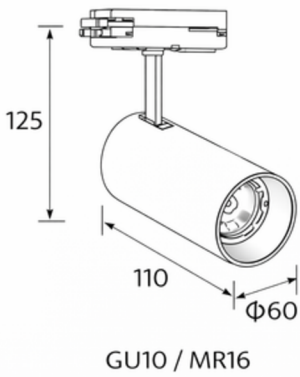

MODEL :
LD55-0110



MODEL :
LD55-0120



MODEL :
LD55-0130



MODEL :
LD55-0310



MODEL :
LD55-0320





MODEL :
LD55-0410



MODEL :
LD55-0420

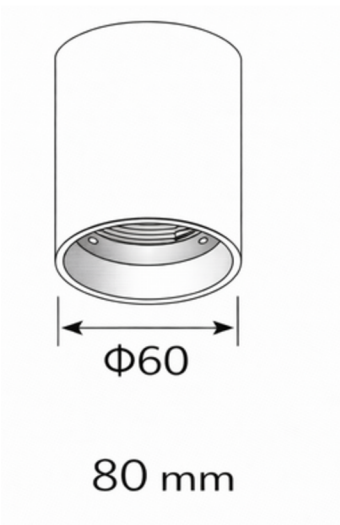

MODEL :
LD56-0010

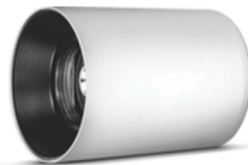

MODEL :
LD56-0020



MODEL :
LD56-0030

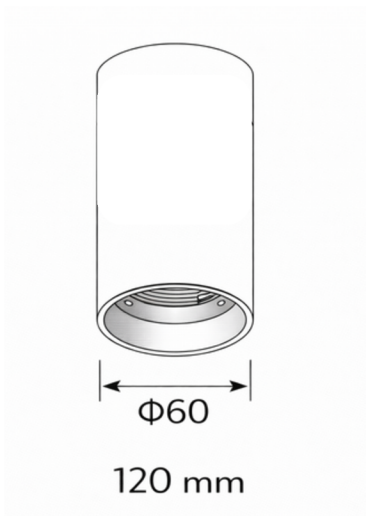

MODEL :
LD56-0110

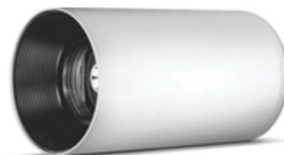

MODEL :
LD56-0120



MODEL :
LD56-0130



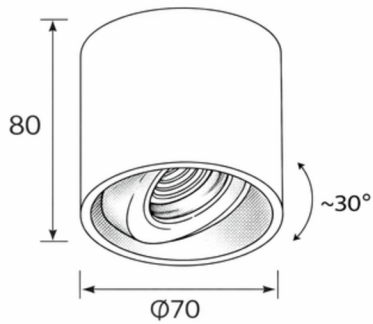

GU10

MODEL :
LD56-2110

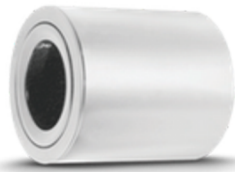

MODEL :
LD56-2120

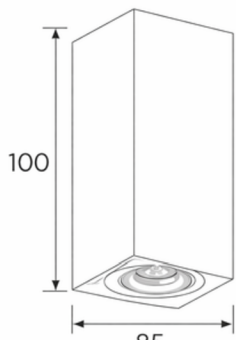
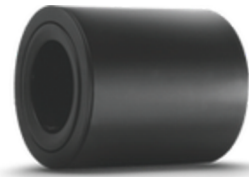

GU10

MODEL :
LD57-0010



MODEL :
LD57-0020



MODEL :
LD57-0030

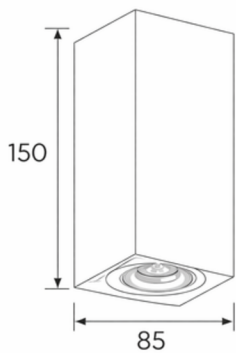
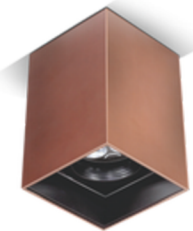

GU10

MODEL :
LD57-0110



MODEL :
LD57-0120



MODEL :
LD57-0130

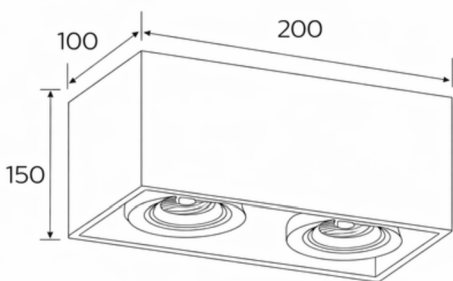

GU10 x2

MODEL :
LD57-2110



MODEL :
LD57-2120



MODEL :
LD57-2130



RIFLETTORI



- MODEL : **KL LF09-1021**
- MODEL : **KL LF09-2021**
- MODEL : **KL LF09-3021**
- MODEL : **KL LF09-5021**
- MODEL : **KL LF10-9021**
- MODEL : **KL LF09-1021 SENSOR**
- MODEL : **KL LF09-2021 SENSOR**
- MODEL : **KL LF09-3021 SENSOR**
- MODEL : **KL LF09-5021 SENSOR**

[W]	[lm]	Tc [K]	IP		SENSOR
10	1200	4000	65	noir nero	
20	2300	4000	65	noir nero	
30	3450	4000	65	noir nero	
50	6000	4000	65	noir nero	
90	10800	4000	65	noir nero	
10	1200	4000	44	noir nero	PIR
20	2300	4000	44	noir nero	PIR
30	3450	4000	44	noir nero	PIR
50	6000	4000	44	noir nero	PIR

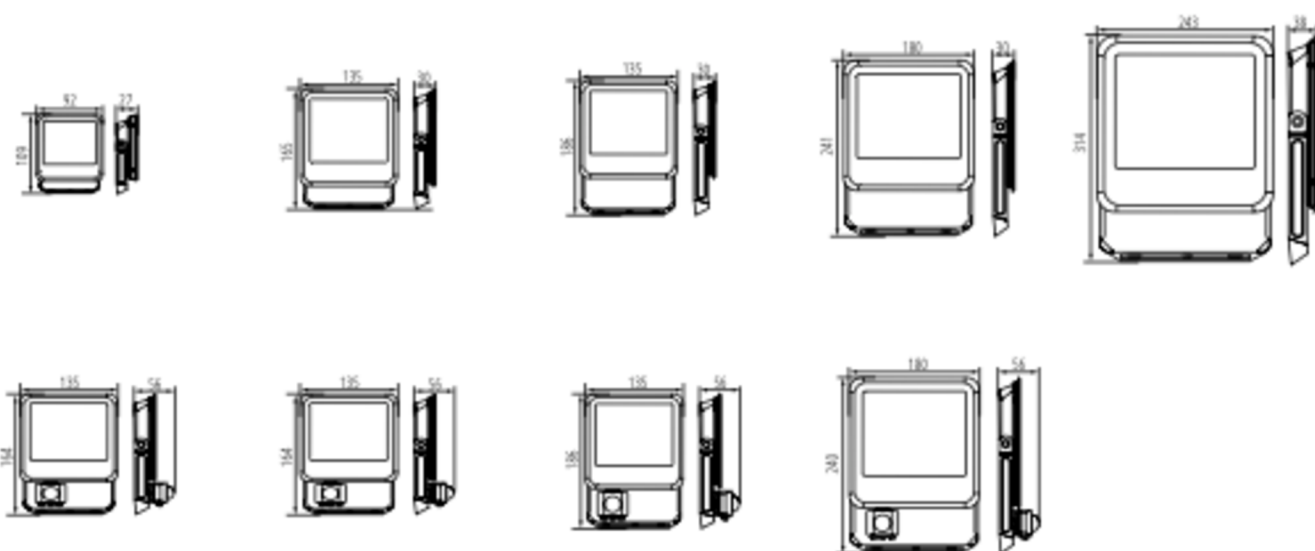

[V] 220-240 AC	[Hz] 50	 100	 ≥25000	 50000	 ≤ 6x MacAdam	 80	 SMD			
 -30+50		 180		 0,3	 1	 1m		CE	EAC	TÜV
UK CA										



MODEL : KL LF09-1024	10	860 \ 1080 \ 970	860	3000\4000\6500	65	gris grigio	F
MODEL : KL LF09-2024	20	1850 \ 2160 \ 1940	1850	3000\4000\6500	65	gris grigio	F
MODEL : KL LF09-3024	30	2400 \ 3240 \ 2910	2400	3000\4000\6500	65	gris grigio	F
MODEL : KL LF09-5024	50	4300 \ 5400 \ 4850	4300	3000\4000\6500	65	gris grigio	F
MODEL : KL LF09-10024	100	8500 \ 10800 \ 9700	8500	3000\4000\6500	65	gris grigio	F
MODEL : KL LF09-1024 SENSOR	10	860 \ 1080 \ 970	860	3000\4000\6500	44	gris grigio	PIR F
MODEL : KL LF09-2024 SENSOR	20	1850 \ 2160 \ 1940	1850	3000\4000\6500	44	gris grigio	PIR F
MODEL : KL LF09-3024 SENSOR	30	2400 \ 3240 \ 2910	2400	3000\4000\6500	44	gris grigio	PIR F
MODEL : KL LF09-5024 SENSOR	50	4300 \ 5400 \ 4850	4300	3000\4000\6500	44	gris grigio	PIR F
MODEL : KL LF09-10024 SENSOR	100	8500 \ 10800 \ 9700	8500	3000\4000\6500	44	gris grigio	PIR F

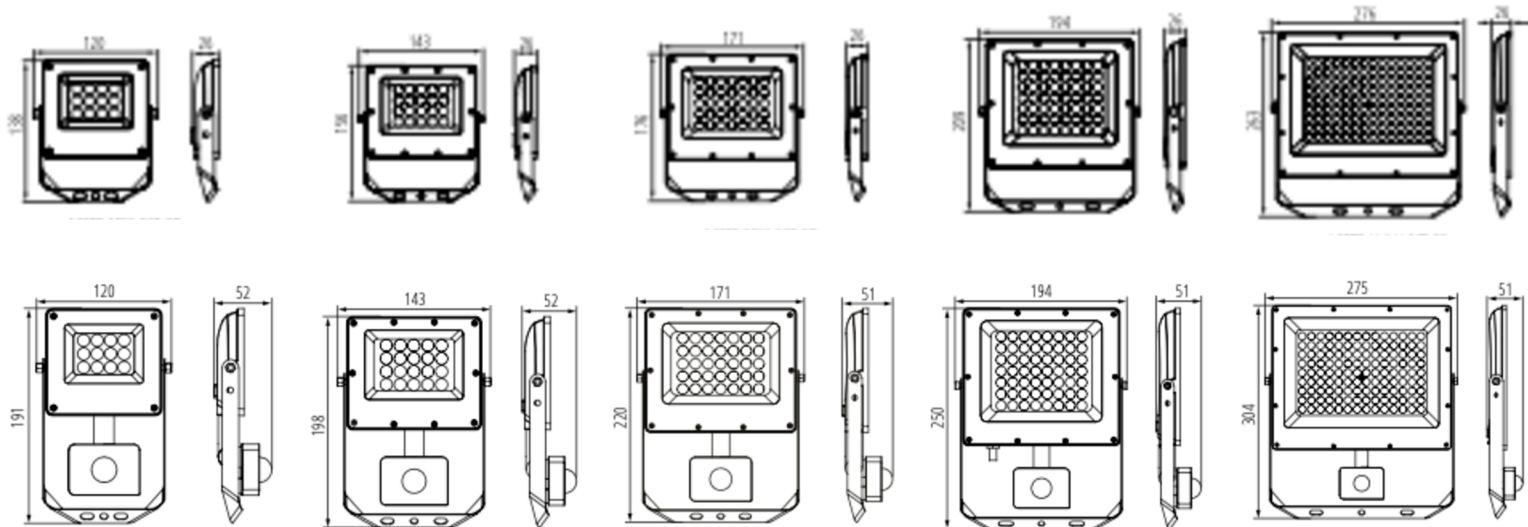

[V] 220-240 AC	[Hz] 50	120° Φuse	90	≥15000	25000	ellipse ≤ 6xMacAdam	Ra ≥80	SMD			
°C -20+40		180	0,2	1	1m	Hg	CE	EAC	UK CA		



MODEL : **KL LF10-5021**



50 6000 5140 4000 noir | nero E

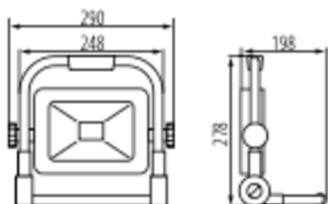

 220-240 AC	 50	 120° Φuse	 120	 ≥15000	 25000	 ellipse ≤ 6x MacAdam	 Ra 80
 SMD	 IP 65	 2	 IP 65	 -20+35	 -20+35	 330	 330
 IK 07	 1m	 2	 1	 1m	 Hg	 CE	 EAC
 UK CA							



MODEL : **KL LF10-20021**



200 30000 33500 4000 60 gris | grigio C

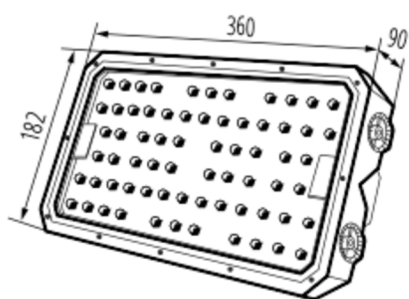

 220-240 AC	 50	 ≥30000	 100000	 ellipse ≤ 6x MacAdam	 Ra 70	 SMD		
 IP 66	 -25+40	 IK 10		 Hg	 1	 1m	 Hg	
 CE	 EAC	 UK CA						

(si possono collegare 2 moduli come in foto)

FARI LED



MODEL : KL LF11-2021	20	2800	4000	X140\Y90	gris grigio	D
MODEL : KL LF11-4021	40	5600	4000	X140\Y90	gris grigio	D
MODEL : KL LF11-6021	60	8400	4000	X140\Y90	gris grigio	D
MODEL : KL LF11-10021	100	14000	4000	X140\Y90	gris grigio	D
MODEL : KL LF11-15021	150	19500	4000	X140\Y90	gris grigio	E
MODEL : KL LF11-20021	200	26000	4000	X140\Y90	gris grigio	E

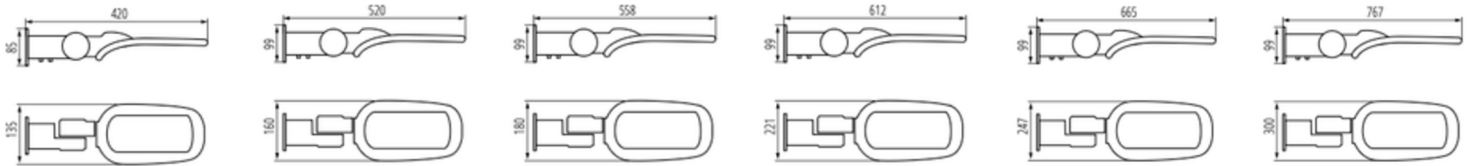

[V] 220-240 AC	[Hz] 50	360° Φ _{use}	≥20000	50000	ellipse ≤ 6x MacAdam	Ra 70
SMD			IP 66		-20+45	IK 08
	0,4 [m]	1 [mm ²]	1m		CE	EAC
UK CA						



MODEL : KL LF11-4020	40	5200	3000	X140/Y90	gris grigio	E
MODEL : KL LF11-6020	60	7800	3000	X140/Y90	gris grigio	E
MODEL : KL LF11-10020	100	13000	3000	X140/Y90	gris grigio	E

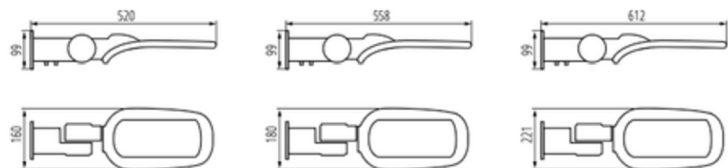

PANNELLI AD INCASTRO



KL LP02



MODEL : KL LP02-0521	5	blanc bianco	400	120	4000
MODEL : KL LP02-0921	9	blanc bianco	900	120	4000
MODEL : KL LP02-1221	12	blanc bianco	1250	120	4000
MODEL : KL LP02-1821	18	blanc bianco	1900	120	4000
MODEL : KL LP02-2421	24	blanc bianco	2600	120	4000
MODEL : KL LP03-0521	5	blanc bianco	400	120	4000
MODEL : KL LP03-0921	9	blanc bianco	900	120	4000
MODEL : KL LP03-1221	12	blanc bianco	1250	120	4000
MODEL : KL LP03-1821	18	blanc bianco	1900	120	4000
MODEL : KL LP03-2421	24	blanc bianco	2600	120	4000

KL LP03

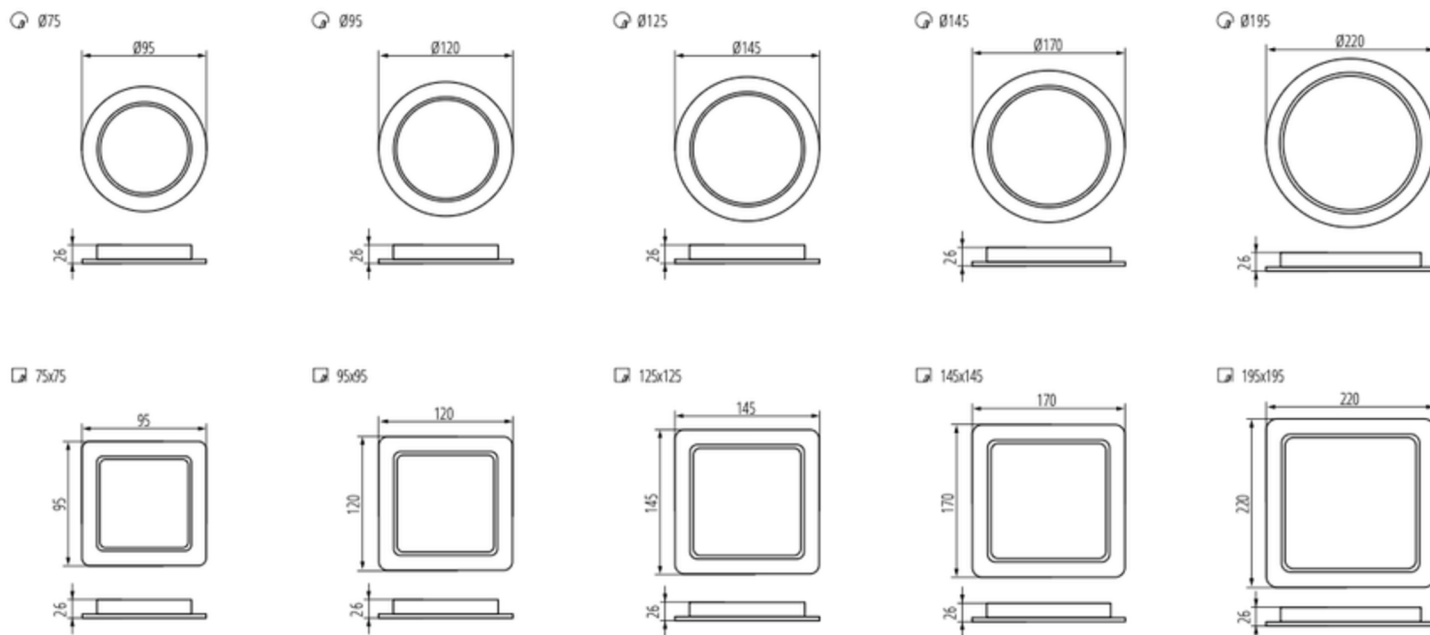

MODEL :

cornice per il montaggio superficiale dei LED
Downlight fitting LP02 e LP03 (da 12w e da 18w)



[W] 220-240 AC	[Hz] 50	≥15000	25000	ellipso ≤ 6x Nachdam	Ra 80	SMD			IP 44\20
	5+25			0,1	0,5m	CE	EAC	UK CA	

MODEL : **KL LP6060**



MODEL : **KL LP6060-2421**

MODEL : **KL LP6060-3420**

MODEL : **KL LP6060-3421**

MODEL : **KL LP6060-3422**

MODEL : **KL LP6060-3821**

MODEL : **KL LP6060-4021 IP65**

MODEL : **KL LP30120-3421**

MODEL : **KL LP30120-3821**



24	4320	4000	115	20	bianco
34	3740	3000	115	20	bianco
34	4080	4000	115	20	bianco
34	4080	6500	115	20	bianco
38	4560	4000	115	20	bianco
40	4800	4000	120	65	bianco
34	4080	4000	115	20	bianco
38	4560	4000	115	20	bianco

MODEL : **KL LP30120**

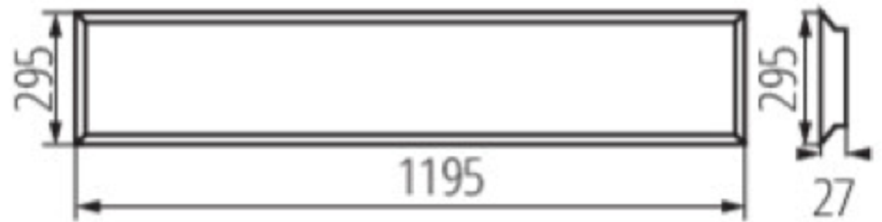
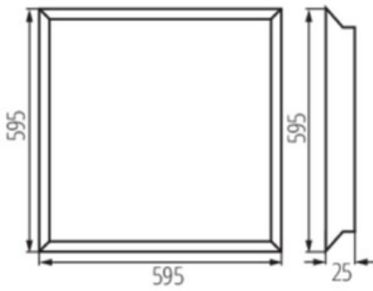

MODEL :

KL FRAME PER MONTAGGIO

SUPERFICIALE PANNELLI 60x60 E

30x120 (su ordinazione)

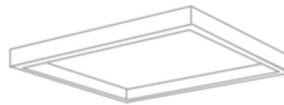
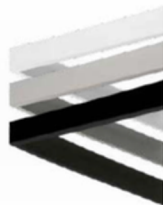

ADTR 12030 - 1200 x 300 x 45mm
ADTR-H 12030 - 1200 x 300 x 65mm

 [V] 220-240 AC	 [Hz] 50	 [h] 50000	 ellipse ≤ 6x/Max/diam	 SMD			 5+25	
 [mm²] 1-2,5	 0,5m							

STRISCE LED

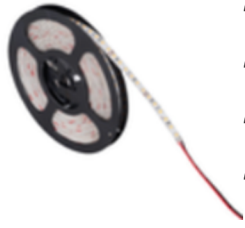

- MODEL : **KL LSMD-1220 IP00**
- MODEL : **KL LSMD-1221 IP00**
- MODEL : **KL LSMD-1222 IP00**
- MODEL : **KL LSMD-1220**
- MODEL : **KL LSMD-1221**
- MODEL : **KL LSMD-1222**

IP 00 - 8 mm; IP 65 - 8,2 mm

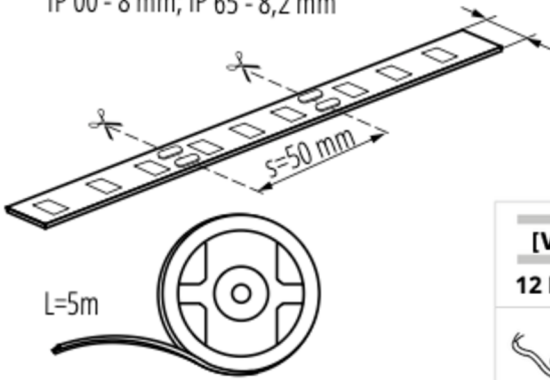

			IP			
[m]	Φ_{use}	Tc [K]		[mm]	ellipse MacAdam	A1 G

0,5m = 5,5	0,5m = 450	3000	00	5000	≤3	G
0,5m = 5,5	0,5m = 450	4000	00	5000	≤3	G
0,5m = 5,5	0,5m = 450	6000	00	5000	≤3	G
0,5m = 5,5	0,5m = 450	3000	65	5000	≤6	G
0,5m = 5,5	0,5m = 450	4000	65	5000	≤6	G
0,5m = 5,5	0,5m = 450	6000	65	5000	≤6	G

12 DC	1m = 11	III	Ra 90	Hg	House	SMD	≥30000	30000 [h]
0,1m	0,1m	5+25 [°C]	360° Φ_{use}	CE	EAC	UKCA		



- MODEL : **KL LSMD-2420**
- MODEL : **KL LSMD-2421**

IP 65 - 8,2 mm

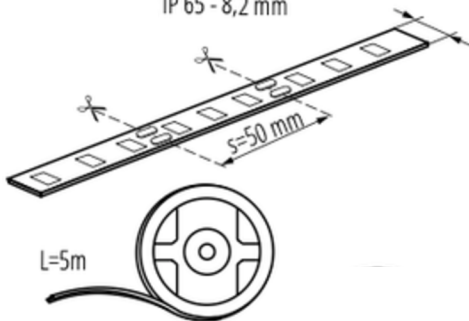

			IP			
[m]	Φ_{use}	Tc [K]		[mm]	ellipse MacAdam	A1 G

0,5m = 8	0,5m = 800	3000	65	5000	≤6	F
0,5m = 8	0,5m = 880	4000	65	5000	≤6	F

24 DC	1m = 16	III	Ra 80	Hg	House	SMD	≥30000	30000 [h]
0,1m	0,1m	5+25 [°C]	360° Φ_{use}	CE	EAC	UKCA		

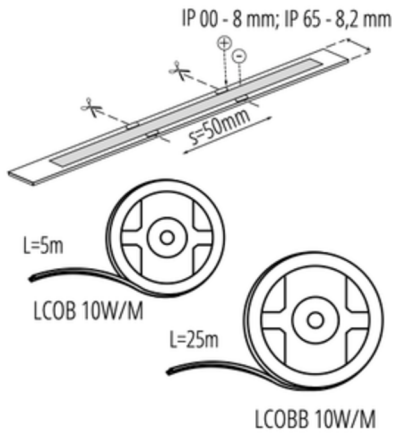

IP

MODEL : KL LCOB-2420 IP00	0,5m = 5	0,5m=460	3000	00	5000	F
MODEL : KL LCOB-2421 IP00	0,5m = 5	0,5m=500	4000	00	5000	F
MODEL : KL LCOB-2422 IP00	0,5m = 5	0,5m=525	6500	00	5000	F
MODEL : KL LCOB-2420	0,5m = 5	0,5m=430	3000	65	5000	G
MODEL : KL LCOB-2421	0,5m = 5	0,5m=460	4000	65	5000	F
MODEL : KL LCOB-2422	0,5m = 5	0,5m=500	6500	65	5000	F

[V] 24 DC						≥30000	30000 [h]
				CE	EAC	UK CA	

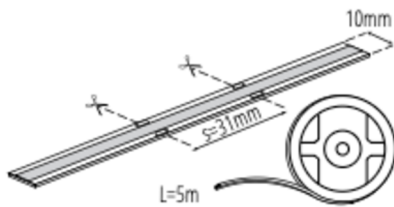

IP

MODEL : KL LCOB 2427 IP00	0,5m = max 7,5	0,5m = max 235	RGB	00	5000
MODEL : KL LCOB-2427 IP65	0,5m = max 7,5	0,5m = max 225	RGB	65	5000

[V] 24 DC	1m = max 15 (RGB)		s in NoAdm				≥30000	30000 [h]				CE	EAC	UK CA	
---------------------	-------------------	--	------------	--	--	--	--------	-----------	--	--	--	-----------	------------	--------------	--



MODEL : **KL LCOB 1220XL**

MODEL : **KL LCOB-1222XL**



IP



0,5m = 5	0,5m=430	3000	65	25000	G
0,5m = 5	0,5m=475	6500	65	25000	F

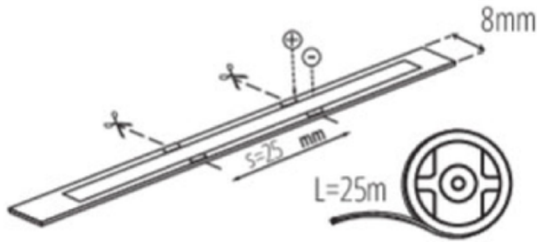

IV 12 DC	III	Ra 90	Hg	House icon	COB	≥30000
30000 ^(h)	Snake icon	0,1m	5±25	360° Φuse	CE	EAC
UK CA	Down arrow icon					



MODEL : **KL LCOB-2420XL**

MODEL : **KL LCOB-2421XL**

MODEL : **KL LCOB-2422XL**



IP



0,5m = 5	0,5m=430	3000	65	25000	F
0,5m = 5	0,5m=460	4000	65	25000	G
0,5m = 5	0,5m=500	6500	65	25000	F

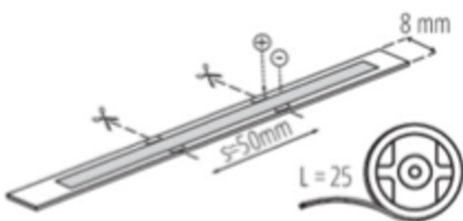

IV 24 DC	III	Ra 90	Hg	House icon	COB	≥30000
30000 ^(h)	Snake icon	0,1m	5±25	360° Φuse	CE	EAC
UK CA	Down arrow icon					

PROFILI LED



MODEL :

LAP-508

1000*24.7*7mm PCS DA 3m



MODEL :

LAP-508BL

1000*24.7*7mm PCS DA 3m



MODEL :

LAP-509

1000*17.4*7mm PCS DA 3m

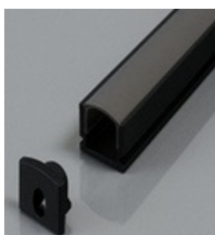

MODEL :

LAP-509BL

1000*17.4*7mm PCS DA 3m

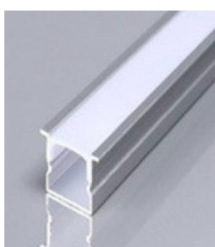

MODEL :

LAP-20*10

1000*20*10mm. PCS DA 3m

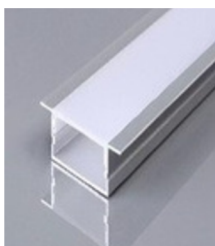

MODEL :

LAP-30*10

1000*30*10mm. PCS DA 5m



MODEL :

LAP-50*20

1000*64*20mm. PCS DA 5m



MODEL :
LAP-53*15

1000*1000*55*15mm PCS DA 5m (



MODEL :
LAP-61*14

1000*1000*W61*H14mm PCS DA 5m

MODEL :
LAP-61*14G

1000*1000*W61*H14mm FLEXIBLE PCS DA 5m



MODEL :
LAP-50*20

1000*1000*W96*H20mm PCS DA 5m

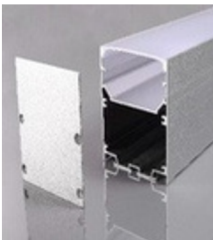

MODEL :
LAP-75*75

1000*75*75mm PCS DA 5m

MODEL :
LAP-75*75BL

1000*75*75mm PCS DA 5m BLACK



MODEL :
LAP-601

1000*15.8*15mm PCS DA 3m

SENSORI

MODEL : **KL LS01-W**

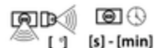

MODEL : KL LS01-W	800	mural, saillie	montaggio a parete , montaggio a soffitto	360	10-12	Hyperfréquence	a microonde
MODEL : KL LS01-B	800	mural, saillie	montaggio a parete , montaggio a soffitto	360	10-12	Hyperfréquence	a microonde

PCS/CARTON: 50

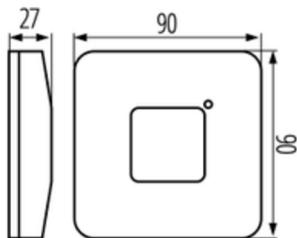

MODEL : **KL LS01-B**



[V]	[Hz]	IP	House icon	Square icon	[m]	[lx]	[°C]	[mm]	CE	EAC	UK CA	Recycling icon
220-240 AC	50	20			max 8	3-2000	5+25	0,75+1,5				

MODEL : **KL LS02 -BB**

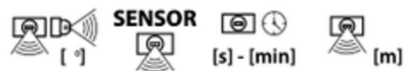

SENSOR

MODEL : KL LS02 -BB	1200	mural	montaggio a parete	120	PIR	10-15	max 10
MODEL : KL LS02 -NW	1200	mural	montaggio a parete	120	PIR	10-15	max 12
MODEL : KL LS02 -NB	1200	mural	montaggio a parete	120	PIR	10-15	max 12

PCS/CARTON: 50

MODEL : **KL LS02 -NW**



MODEL : **KL LS02 -NB**

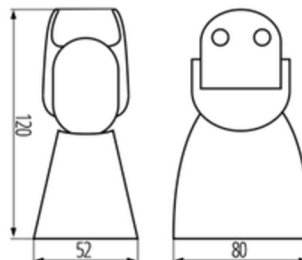
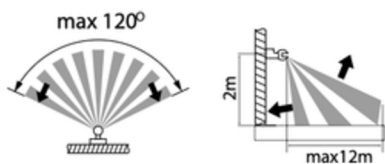

[V]	[Hz]	IP	House icon	Square icon	[lx]	[°C]	[mm]	CE	EAC	UK CA	Recycling icon
220-240 AC	50	65			3-2000	-20+40	0,75+1,5				

PLAFONIERE STAGNA LED

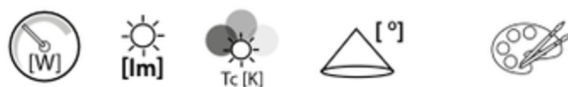

MODEL : KL LW01-4021	40	4400	4000	X145\Y110	blanc bianco
MODEL : KL LW01-5021	50	5500	4000	X145\Y110	blanc bianco

PCS/CARTON: 50

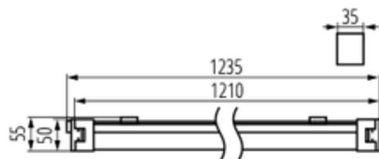

[V] 220-240 AC	[Hz] 50	≥20000	25000	ellipse ≤ 6x MacAdam	Ra 80	SMD		IP 65	
[°C] -20+40	IK 08	[mm²] 1-2,5	[m] 0,5m	CE	EAC	UK CA			

PLAFONIERA STAGNA LED



MODEL : KL LW02-1921	19	2400	4000	110	gris grigio
MODEL : KL LW02-2621	26	3900	4000	110	gris grigio
MODEL : KL LW02-3821	38	5000	4000	110	gris grigio
MODEL : KL LW02-4821	48	6400	4000	110	gris grigio

PCS/CARTON: 50

MODEL : **KL LW02-1921**



MODEL : **KL LW02-2621**

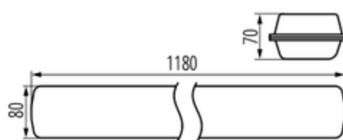

MODEL : **KL LW02-3821**

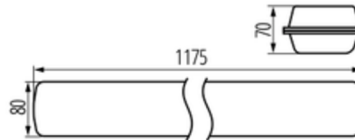

MODEL : **KL LW02-4821**

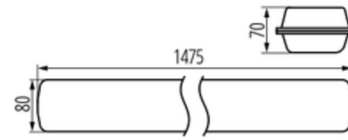

[V] 220-240 AC	[Hz] 50	≥15000	50000	ellipse ≤ 6x MacAdam	Ra 80	SMD		IP 65	
[°C] -20+40	IK 08	[mm²] 1,5÷2,5	[m] 0,5m	CE	EAC	PZH	UK CA		

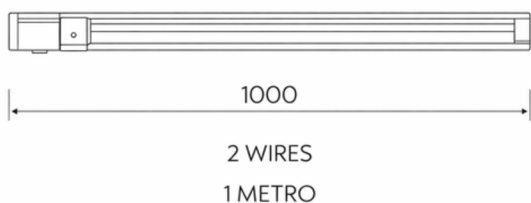

MODEL :
LT01-F23B



MODEL :
LT01-F23W



PCS/CARTON: 20



MODEL :
LT02-F23B



MODEL :
LT02-F23W



PCS/CARTON: 20



MODEL :
LT03-F23B



MODEL :
LT03-F23W



PCS/CARTON: 20

MODEL :
KL LT01-F33W



MODEL :
KL LT01-F33B



MODEL :
KL LT02-F33W

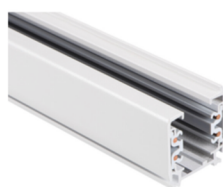

MODEL :
KL LT02-F33B



MODEL :
KL ACCESSORI PER BINARI (su ordinazione)

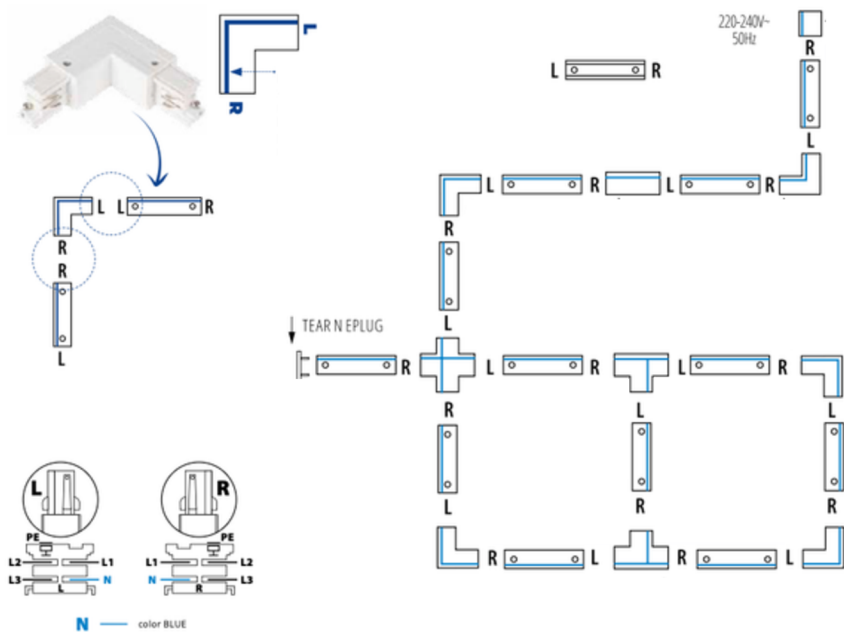

[V] 220-240 AC	[Hz] 50	In[A] 16	⊕	IP 20	🏠	☀️ 5+25	🔌	CE	EAC	PZH	UK CA	📶
-------------------	------------	-------------	---	----------	---	------------	---	----	-----	-----	----------	---

MODEL :

KL LPE LED LINEARI PERSONALIZZABILE SU MISURA (su ordinazione)



BIANCO

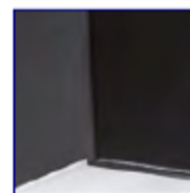

NERO



ARGENTO

